

**PCR-100
PCR-110**

**Installation and Operating
Instructions**

Electronic thermostat

TABLE OF CONTENTS

1 Unpacking the unit and conditions of use	3
2 General instructions	3
3 Use and function	3
3.1 Use for the purpose intended	3
3.2 Function	4
4 Safety	4
4.1 Sources of danger	4
4.2 Safety precautions	5
5 Installation and commissioning	5
5.1 Mechanical installation	5
5.2 Electrical installation	6
6 Operation of the controller	7
6.1 Switching on the operating voltage	8
6.2 Display	8
6.3 Key functions	8
6.4 Adjusting the cold store temperature	9
6.5 Manual defrost	9
7 Programming	9
7.1 Input parameters and ranges	10
7.2 Sensor calibration (Parameter E 06)	11
8 Maintenance	12
9 Appendix	12
9.1 Alarm messages	12
10 Conditions of warranty	13
11 Technical data	13

1 Unpacking the unit and conditions of use

Before and when unpacking the unit, make a visual inspection to identify any possible damage which may have occurred during transportation. Please look for loose parts, dents, scratches, etc.

Report any damage immediately to the freight company. (Please see "Conditions if damage has occurred".) In other instances, the latest edition of the "General conditions for the supply of goods and services" issued by the ZVEI (German Central Association for the Electrotechnical Industry) shall apply.

Before disposing of the packaging, please check it for loose functional parts and information leaflets.

So that we can process warranty claims, please give an exact description of the defect (with a photograph, if appropriate) and state the model designation of the unit.

Please keep these operating instructions at the place where the equipment is used.

2 General instructions

Work on the electrical devices and switching equipment may only be carried out by appropriately qualified personnel. The relevant safety and environmental regulations must be followed.

FLICA equipment is free from PCBs, PCTs, asbestos, formaldehyde, cadmium and water-repelling substances.

The design of the equipment has taken into account the Standards EN 50081-1,2 (emitted interference), EN 50082-1 (immunity to interference), EN 60335-1 (electrical safety), IEC 695-2-1 to -2-3 (fire resistance, glow-wire test).

Safety tests have been performed in the factory on all equipment in accordance with EN 60335-1 (DIN VDE 0700 T500).

3 Use and function

3.1 Use for the purpose intended

- This controller is designed to control ambient temperatures or media temperatures in refrigeration or heating systems.
- The controller must not be used as a safety cut-out device or excess temperature limiter.

If the unit is used for purposes other than those stated here, it shall not be considered to be use for the purpose intended.

- Only connect sensors supplied with the unit. If a replacement sensor is required, only use sensors of the same type (Part No. H61007).
- The controller is **not** intended for use in vehicles because the possible operating voltage ranges, interference level and environmental operating exceed the limits for which the controller can be used.
- Please take the application limits into account (see Technical Data in section 11).

3.2 Function

- PCR-100 and PCR-110 are general-purpose thermostats, each with a relay output and wide temperature control range (-55 °C to +50 °C).
- The controllers have different housings:
PCR-100: Modular housing for 35 mm standard rails
PCR-110: "Snap-in" installation housing, which fits into aperture 28.5 x 70.5 mm.
- Control performance: 2-step, on/off, with reversible direction for heating and refrigerating.
- Defrost option for chilling systems if continuous operation of the evaporator fan is foreseen in the switching box.
- Easy to operate thanks to digital input of setpoint value and switching difference.
- Data is not lost, even if there is a power failure, for at least 10 years.
- Alarm output.

4 Safety



4.1 Sources of danger

- Caution - Mains voltage!
- Never expose the unit to water or moisture. Risk of malfunction and short circuit. Only use the unit when it is adjusted to normal ambient temperature (+15 to. +30 °C). Extreme changes in temperature in combination with high atmospheric humidity may lead to the formation of condensed water.
- Even if the control circuit is switched off, high voltage may still be applied to the controller. For this reason, **isolate all electric circuits before starting any service work.**
- Never expose the unit to excessive heat, dust and vibrations. Avoid knocks and pressure loads. If the housing is damaged, there is a risk of an electric shock causing death or injury.

- If the unit cannot be operated without the risk of danger, it must be taken out of service and precautions taken so that it cannot be switched on again unintentionally.

This applies, in particular, if:

⇒ the housing has damage which is visible,

⇒ the unit is no longer operational or

⇒ it has been stored for a long time in unfavourable conditions.

- The unit must not be opened. If it is thought that the unit may be defective, send it back to the dealer or manufacturer with a precise description of the fault.



4.2 Safety precautions

- All electromagnetic loads (solenoid valves, contactors, horns, motors) should be interference suppressed directly at the coil with RC elements.
- Please note the maximum contact rating of the relays and terminals.

If this is not observed, there is a risk that the contacts may pit or stick, with the result that the refrigeration system will not operate correctly and the refrigerated items may be damaged.

- Sensor leads are to be routed separately from mains voltage wires: the clearance should be at least 5 cm.
- Sensor leads must not be routed in multiple cables with other leads carrying mains voltage, otherwise the system may malfunction.
- Tighten the terminals carefully; excessive strain will result in damage to the controller.

5 Installation and commissioning

5.1 Mechanical installation

- **4 DIN Standard modular housings to be mounted on a standard rail:**

a) housing with 2 mounting tabs:

Open out the side mounting tabs; clip the unit on to the 35 mm rail and press tabs in again.

b) housings with 1 mounting tab:

Put housing on the upper 35 mm rail. Clip the unit on the 35 mm rail, lower tab clips on the rail automatically.

To remove the unit from the rail press in lower mounting tab a screw driver, lift unit.

- **Snap – in housings:**
Fit the unit in an aperture 28,5 x 70,5 mm and secure it with the relevant mounting frame.

**a) housings with terminal box coverplate
(max. wall thickness 22 mm)**



**b) housings without terminal box cover plate
(max. wall thickness 18 mm)**

for walls thicker than 10 mm: remove lateral plastic spacers from the mounting frame. For the final fixing of the unit the side screws have to be tightened carefully.

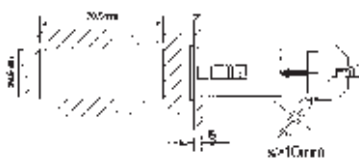

- Use a cable clamp to secure sensor T1 in a suitable position.



5.2 Electrical installation

- ⚡ **CAUTION:** The mains voltage and system frequency must be the same as the nominal values on the device's rating plate. Work on electrical systems must be performed by qualified personnel. Relevant local safety regulations must be observed.

Wiring diagram:

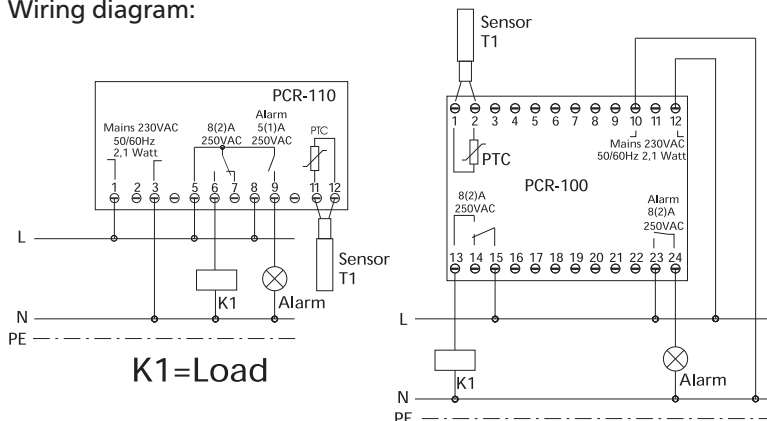

☛ **Instructions:**

- For PCR-110 the total current via terminal 5 of the common relay connection must not exceed 10 A.
- Pay attention to the contact loading of the relay (8A/5A resistive load, 2A/1A inductive load). As a general rule, contactors are recommended.
- The maximum tested sensor cable length is 50 m, with a minimum cross section of 2 x 0.75 mm². Solder the extension cable to the sensor cable to prevent contact resistances.
- It is advisable to use shielded sensor extension cables. All shields must be routed at the side of the controller to **one** earth/protective potential. The extension cable shield must not be connected on the sensor side, otherwise bonding currents may occur via the shielding.
- The controllers are designed respecting the highest degree of immunity to interference. If the local interference level exceeds the immunity data might get lost (AL1 in display) and the controllers switches to the preprogrammed setting values. This is not a malfunction of the controller. In such cases the means to suppress interference have to be improved (RC-elements, shielded lines).

6 Operation of the controller

Front view of controller:

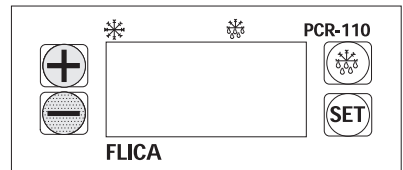
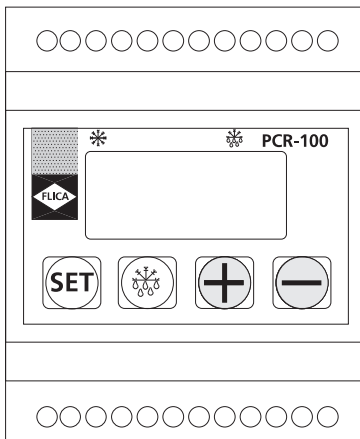

6.1 Switching on the operating voltage

The controller is started by means of a control switch provided by the customer.

The first time the controller is started, pre-programmed setting values are used which at a later point can be adapted for individual requirements.

If alarm "AL 2" (temperature in refrigerated chamber too high or too low) is displayed when the controller is switched on, this can be cleared by pressing the ⊕ key.

6.2 Display

During normal operation the current cold store temperature is displayed. It is measured with cold store sensor T1.

In the event of an alarm, the most recent alarm message (e.g. **AL1**) and the cold store temperature are displayed alternately.

Two spot indicators show the switching status of the relays during operation:

Pos. 1: On : Relay on.

Off: Relay off.





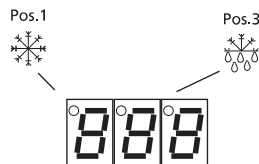

Flashes: Start-up delay E03 active.









Pos. 3: On : Defrost interval is active – relay de-energized.





6.3 Functions of keys

⚠ Never operate the keys with sharp objects (screwdriver or similar).

Display of setpoint value	Press and hold down  key.
Clear alarm messages	Press  key. (If the sensor is faulty, switch mains voltage ON/OFF).
Manual defrost initiation	Press  key for 5 secs.
Display of time until the next defrost	Press  and  keys in sequence and hold both down. (Display in hours and minutes).
Display limit value for excess temperature (cold store sensor T1)	Press  key.

- Input values are always changed using the  or  key with the  key held down.
- Input parameters, e.g. the switching difference is shown as "E" with a 2-digit number, e.g. "E 01".
- **Access to the programming level** is by pressing the  and  key at the same time for 5 seconds.
The parameters to be changed can then be accessed by pressing the  and  keys.
- **To exit from the programming level** and save the data, press the  key after the last input parameter. If no key is pressed in the programming level for 10 minutes, this mode will be exited **without** the data being saved.
- Do not display altered parameter data before saving the data, as it would be reversed to its original value in the process.

6.4 Setting the cold store temperature

Press and hold down the  key. Adjust the setpoint on the value in question using the  or  key.

Adjustment is possible within the limits of the input parameters E01 and E02.

The factory setting is +4°C.







6.5 Manual defrost

Press and hold down the  key for 5 seconds. The manual defrosting process will be initiated by forcibly de-energizing the relay.

If parameter E09 is set to 0: no defrosting will be started.

7 Programming

Access to the programming level:

- Press and hold down firmly the  and  keys at the same time for approx. 5 seconds. (**E00** appears on display.)
- Use  or  key to select parameters.
- Setting: Press and hold down the  key. Adjust the setpoint value to the desired figure using the  or  key.
- Do not display altered parameter data before saving the data, as it would be reversed to its original value in the process.

7.1 Input parameters and input ranges:

Parameter on display (⊕ or ⊖)		Setting range (⊕) and (⊖ or ⊕)	Preset
E00	Cold store temperature difference	1 to 20 K	2 K
E01	Min. permissible cold store temp.	-55 °C to E02	-55 °C
E02	Max. permissible cold store temp.	E01 to +50 °C	+50 °C
E03	Delay time, relay energizing	0 to 15 mins.	5 mins.
E04	Alarm temperature difference	-50 K to +50 K	20 K

If the set temperature difference E04 is negative, an alarm is given if it is too cold in the refrigerated area,
 e.g. E04 = -10 K, cold store setpoint value = 18°C
 → alarm at -28 °C in refrigerated area.

If the set temperature difference E04 is positive, the alarm is given if it is too warm in the refrigerated area,
 e.g. E04 = +10 K, cold store setpoint value = -18°C
 → alarm at -8°C in refrigerated area.

Attention: any change of coldstore set point value changes also the alarm temperature.

If E04 is set to 0, no alarm will be given.

E05	Alarm delay time	0 to 99 mins.	10 mins.
E06	Sensor calibration T1	-5 to +5 K	0 K
E07	Mode selection	1 = Cooling, 2 = Heating	1

E08	Time between 2 defrost cycles (switch off cooling)	1 to 24 hours	8 hours
------------	--	---------------	---------

- ☛ **Once the controller has been switched on, defrosting occurs for the first time at the end of the first time interval.**
- ☛ **After defrosting has been initiated manually, the next time defrosting takes place is after a complete time interval has elapsed.**

- ☛ **If the time interval between two defrost cycles is changed when the system is in operation, the new time interval will not be applied until after the next time defrosting has occurred.**

E09	Defrost time (0 = no defrosting)	0 to 99 mins.	25 mins.
E10	Max. display delay after defrosting	0 to 99 mins.	15 mins.
☛	During the defrosting process, the last current temperature before defrosting started is retained in the display. After defrosting, the display returns to the instantaneous temperature when the stored value is reached again or, at the latest, after time E10 has elapsed.		
E11	Operating of relay if sensor T1 defective	0 = Relay de-energized 1 = Relay permanently energized 2 = On/off in sequence, according to the times set in E12 and E13.	2
E12	"On" time at E11	1 to 99 mins.	15 mins.
E13	"Off" time at E11	1 to 99 mins.	15 mins.

Exiting programming mode:

Press the  key after the last level has been entered.

7.2 Sensor calibration (parameter E06)

The sensor can be calibrated.

Note on sensor calibration: Additional line resistance of 7 Ω in each case, caused by sensor cable extension, results in a change in the temperature display by +1K.

How to proceed: Measure the temperature with a calibrated thermometer or submerge the sensor in well-mixed ice water (0 °C).

Compare the measured temperature with the temperature shown on the unit display.

If the measured temperature is lower than the one displayed, set the negative difference as the programming value (e.g. - 2 K).

If the measured temperature is higher than the one displayed, set the positive difference as the programming value (e.g. 2K).

The temperature display is then corrected by the set value.

8 Maintenance

The controller does not require any maintenance. It does not have any fuses so, if brief voltage spikes occur, the refrigeration system will not stop operating for a prolonged period. Once the disturbance has passed, the controller will automatically start up again.

Cleaning the housing: Only a dry anti-static cloth may be used to wipe clean all plastic parts. Do not use water or cleaning agents containing solvents.

9 Appendix

9.1 Alarm messages

If an alarm occurs, the alarm output will be activated and on the display a code will alternate with the cold store temperature.

Display	Meaning
AL1	Data lost from program memory. The preset values will be used as an emergency program. The setpoint will be set to +4 °C.
AL2	Limit value (= specified value + E04) at sensor T1 exceeded and delay time E05 elapsed.
AL3	The sensor temperature is over 50 °C or below -55°C.
AL4	The specified setpoint value is outside the limits E01 and E02
AL5	Temperature sensor T1 – short circuit or break in wiring. Compressor operates as a function of parameter E11

Clearing the alarm:

Press the  key.

All alarm messages, with the exception of AL2, are also reset by switching off the operating voltage. AL2 can only be reset using the  key.

10 Conditions of warranty

- Warranty is provided for a period of 24 months, starting at the date the item was delivered. Proof of this should be furnished in the form of a delivery note or invoice.
- All functional faults caused by poor workmanship or faulty materials will be repaired free of charge during the warranty period.
- More extensive claims, in particular for consequential damage, are excluded.
- Damage or malfunctioning caused by the equipment being handled incorrectly or by non-compliance with the operating instructions shall not be covered by the warranty.

The warranty shall be invalidated if any work is carried out on the appliance.

11 Technical data

Mains voltage/frequency:	230 V AC \pm 10%, 50/60 Hz
Rated wattage:	2.1 watts
Display:	3-digit, 7-segment LED, red, 14.2 mm
Resolution:	1 K
Measuring range:	-55 to +50 °C
Outputs:	1 relay with changeover contact, 8 A, 230 V AC, resistive load 1 relay with N.O. contact, 5 A, 230 V AC, resistive load, (alarm)

Caution: For PCR-110 the total current via the common relay connection, terminal no. 5, must not exceed 10 A.

Control performance:	Two-step
Display accuracy:	± 0.5 K internal, ± 1 digit, at 25 °C
Operating conditions:	0 to 50 °C, 30 to 85 % R.H., excluding dew
Storage temperature:	-20 to +80 °C
Data back-up:	Non-volatile memory (EEPROM)
Sensor:	1 PTC
- Sensor cable length:	2.5 m
- Range where cable can be used:	-30 °C to +80 °C not fixed -40 °C to +80 °C fixed
- Sensor accuracy:	± 2 %
Housing:	PCR-100: L x W x H = 85 x 70 x 61 mm PCR-110: L x W x H = 70 x 74 x 32 mm ABS plastic, self-extinguishing (UL 94 V0)
Protective rating:	Housing: IP 20, Front panel: IP 52 Class of protection 2
Terminals:	10 A screw-type terminal strips, with wire protection, tightening torque 0.6 Nm Max. core cross section 1.5 mm ²
Weight:	PCR-100: Approx. 330 g (inc. sensor). PCR-110: Approx. 240 g (inc. sensor).

Only operate the unit in dry places.

Errors in the technical data are excepted. We reserve the right to make changes without prior notice.

EC Declaration of Conformity

as defined in the
EMC Directive 89/336/EEC
and the
EC Low Voltage Directive 73/23/EEC

Product: FLICA, Electronic thermostat
Model designation: PRC-100, PCR-110

has been developed, designed and manufactured in accordance with the EC Standards listed above.

The following harmonized Standards have been applied:

EN 50081-1 (1991)

Part 1 for the trades sector, emitted interference

EN 50081-2 (1993)

Part 1 for the industrial sector, emitted interference

EN 50082-1 (1991)

Part 1 for the trades sector, immunity to interference

EN 60335-1 (1993-03-09)

IEC 335-1 (1976) ed 2

Electrical safety, part 1: general requirements

EN 60730-1 (1992-12-09)

IEC 730-1 (1986) ed 1

Automatic electronic controls

Full technical documentation is available.

Operating instructions for the device are provided.

Mosbach, March 22nd, 1999

Honeywell Flica
Honeywell AG
Hardhofweg
D-74821 Mosbach



i.V. Dr. Osthues
R & D / Production Manager

Honeywell

Automation and Control Solutions

Honeywell GmbH

Hardhofweg • 74821 Mosbach / Germany

Phone: +49 (0) 62 61 / 81-475

Fax: +49 (0) 62 61 / 81-461

E-Mail: Cooling.Mosbach@honeywell.com

www.honeywell-cooling.com

Manufactured for and on behalf of the
Environment and Combustion Controls
Division of Honeywell Technologies Sàrl,
Ecublens, Route du Bois 37, Switzerland
by its authorised representative Honeywell GmbH